











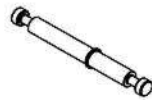

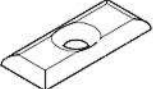

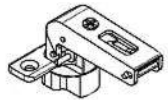

# WARDROBE 2D LISA

Art. code: 116 17 911

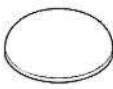
 8 x 30 A x 20	 B x 50	 C x 44	 D x 3	 3,5 x 13 E x 24	 2,5 x 16 F x 66	 G x 12
 H x 2	 I x 16	 J x 2	 4 x 45 K x 4	 L <sub>1</sub> x 8	 L <sub>2</sub> x 8	 M x 4
 N x 6	 O x 1	 P x 1	 8 x 60 R x 2	 S x 1	 T x 4	 6 x 25 K x 4

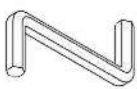
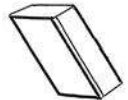
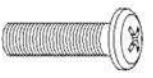
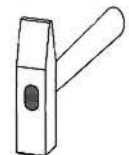
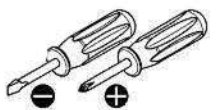
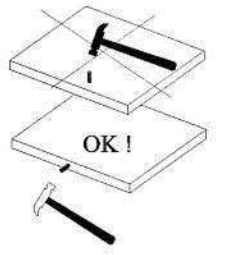
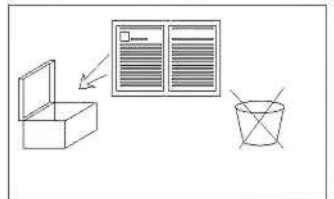
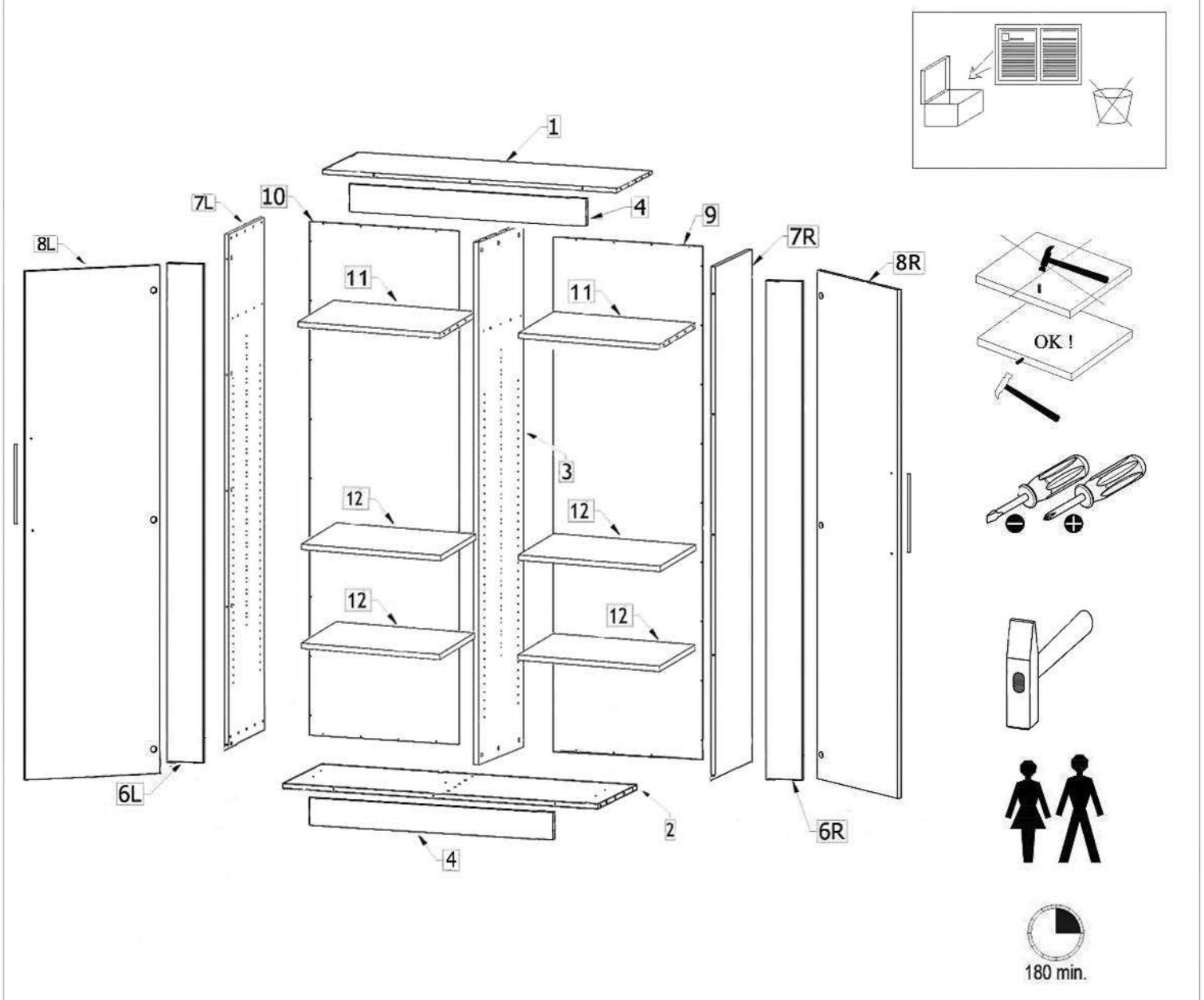

1

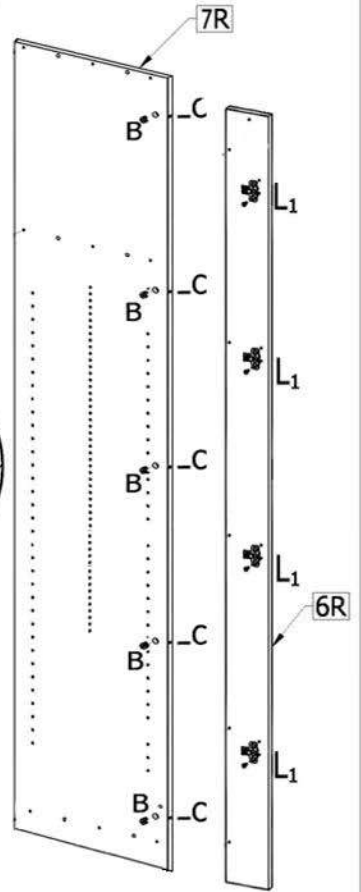
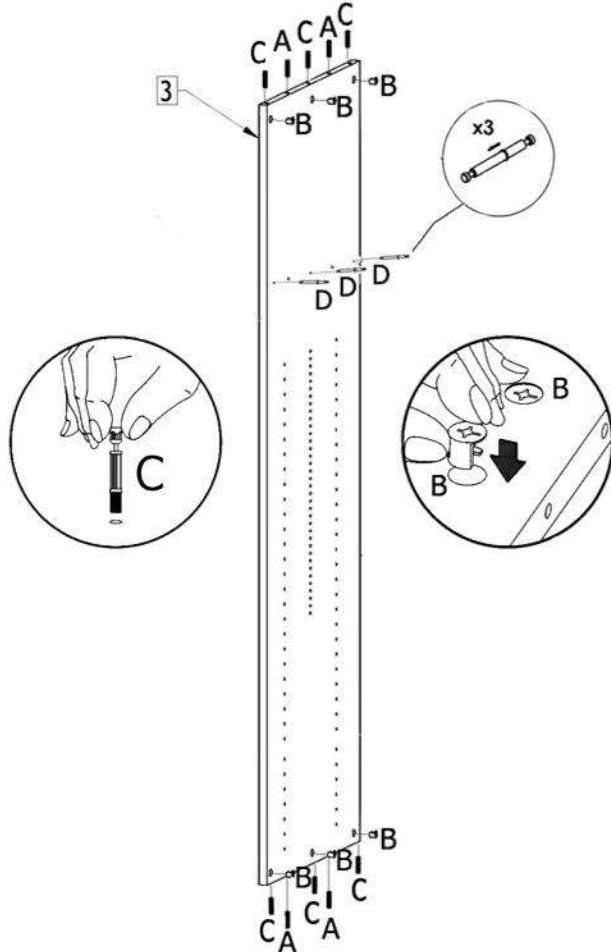
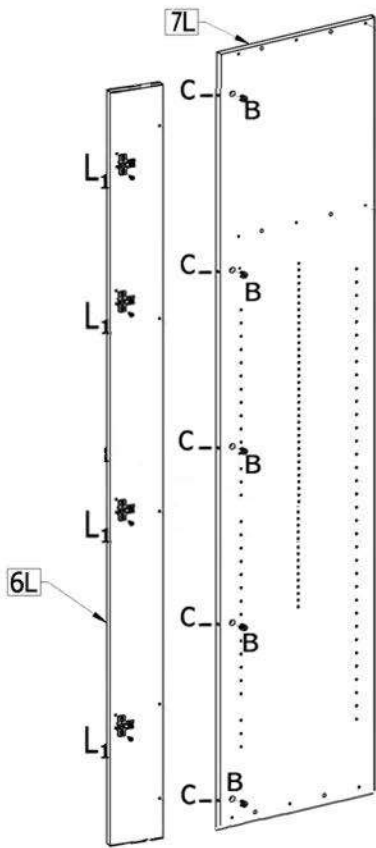

2

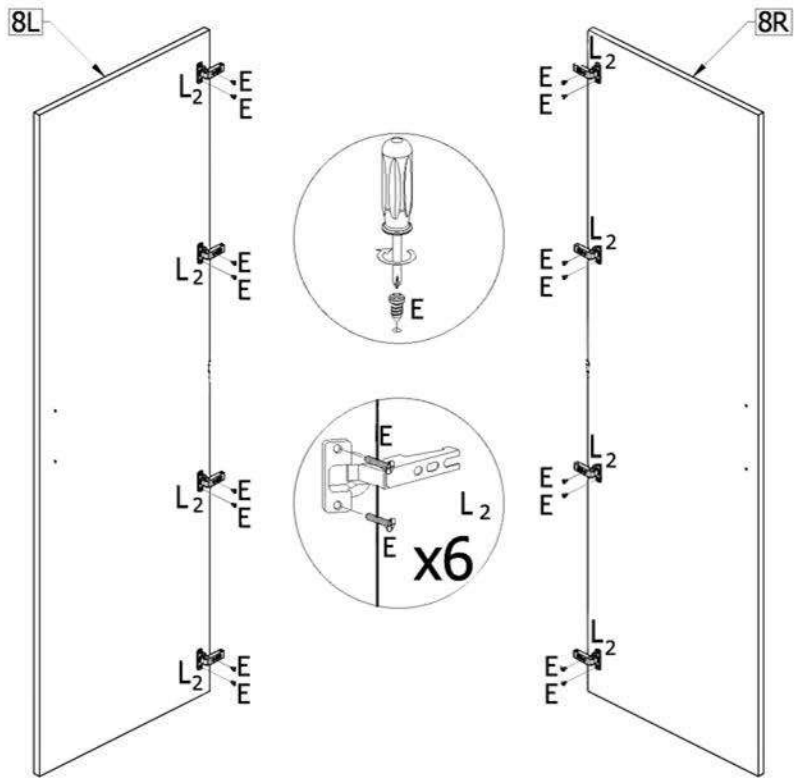
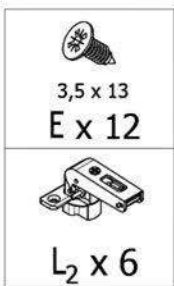

3

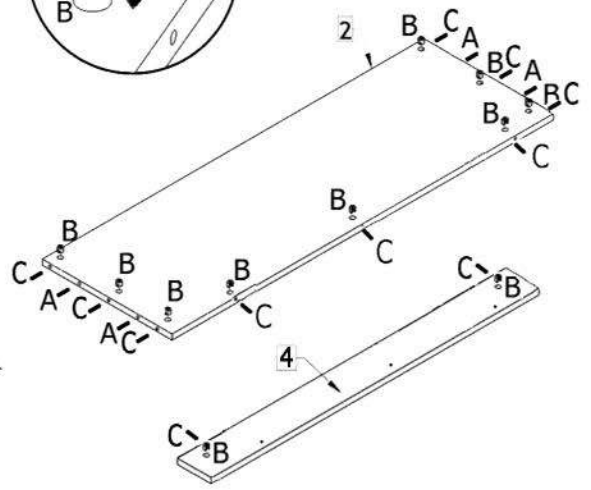
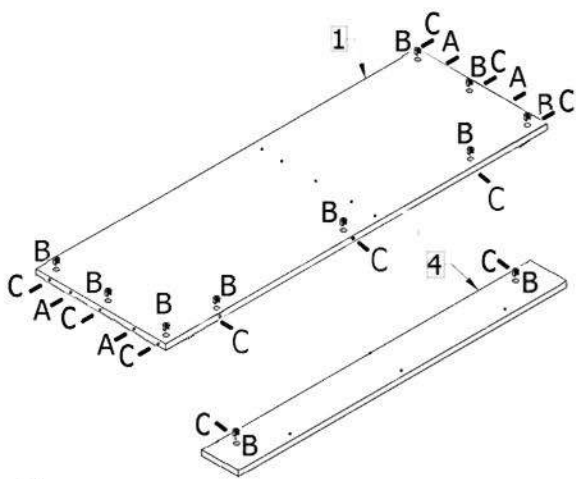
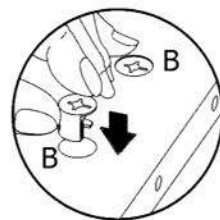

4

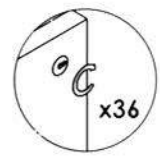
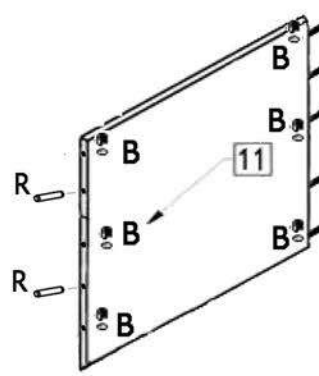
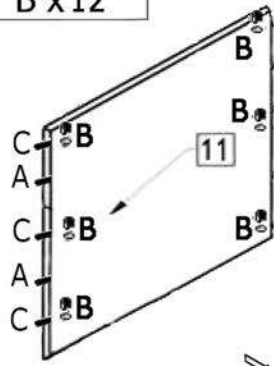
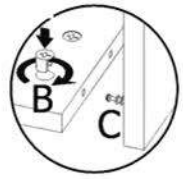
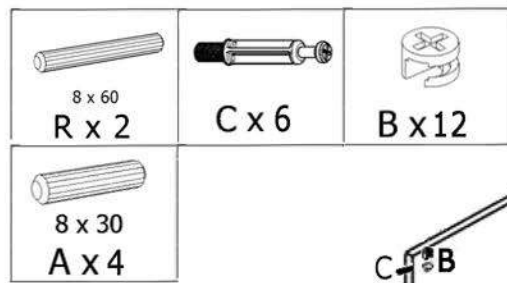

5

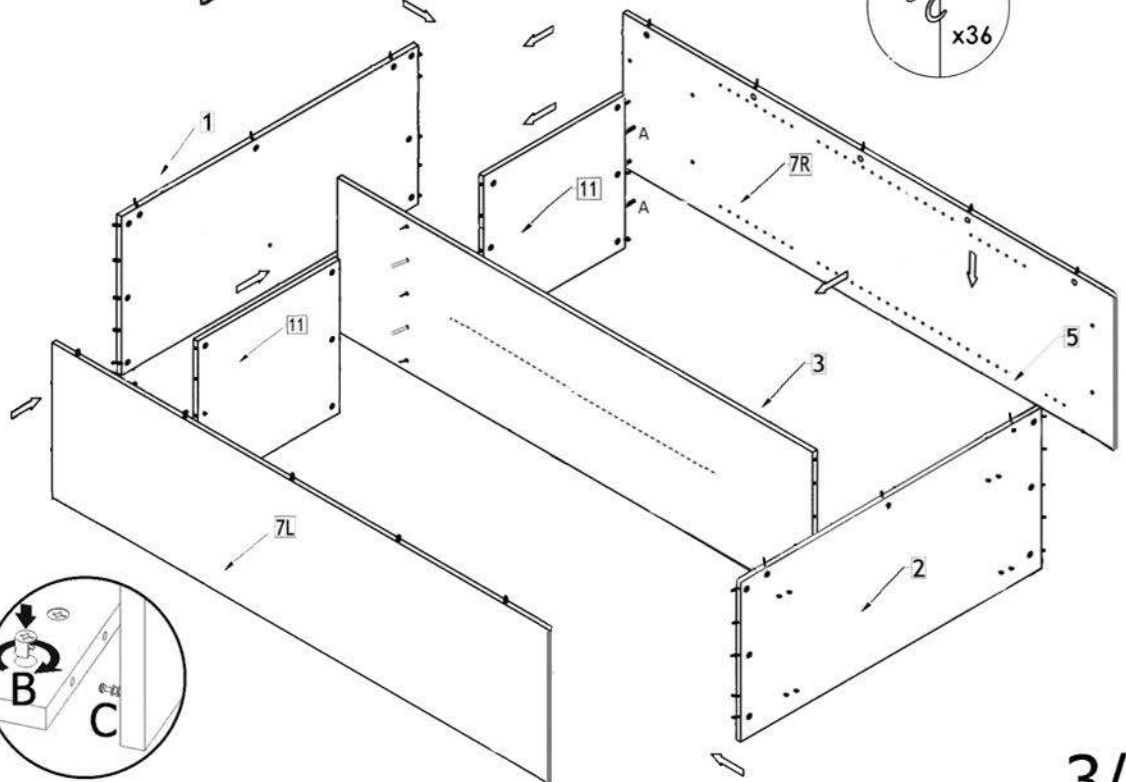



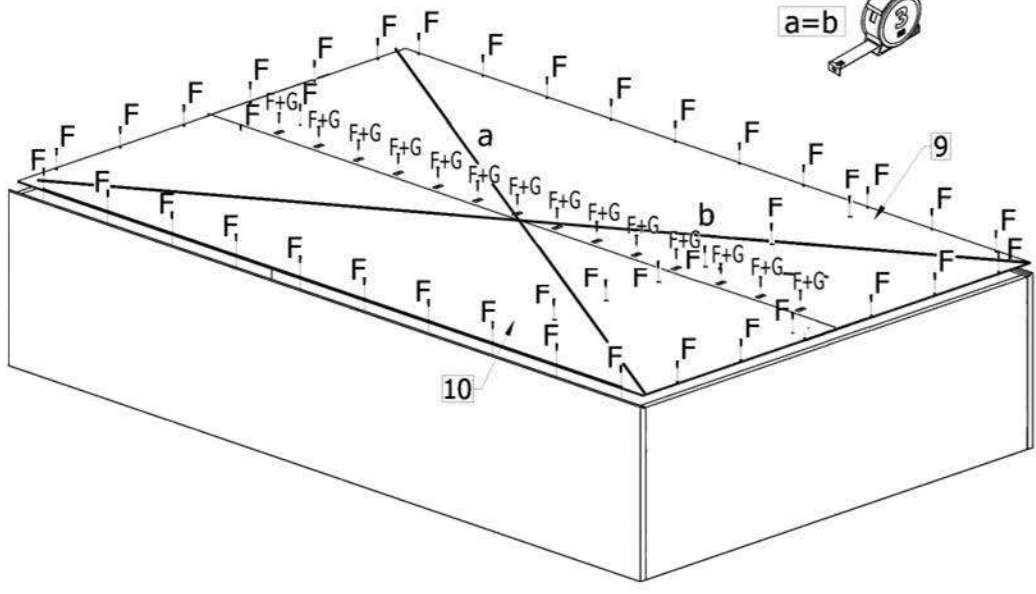
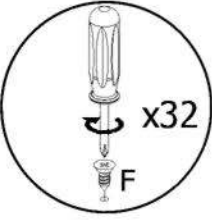
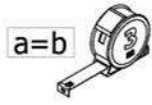
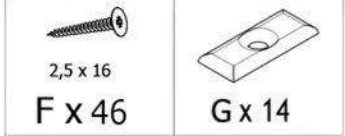

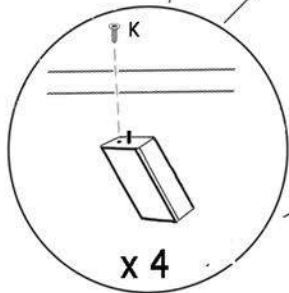
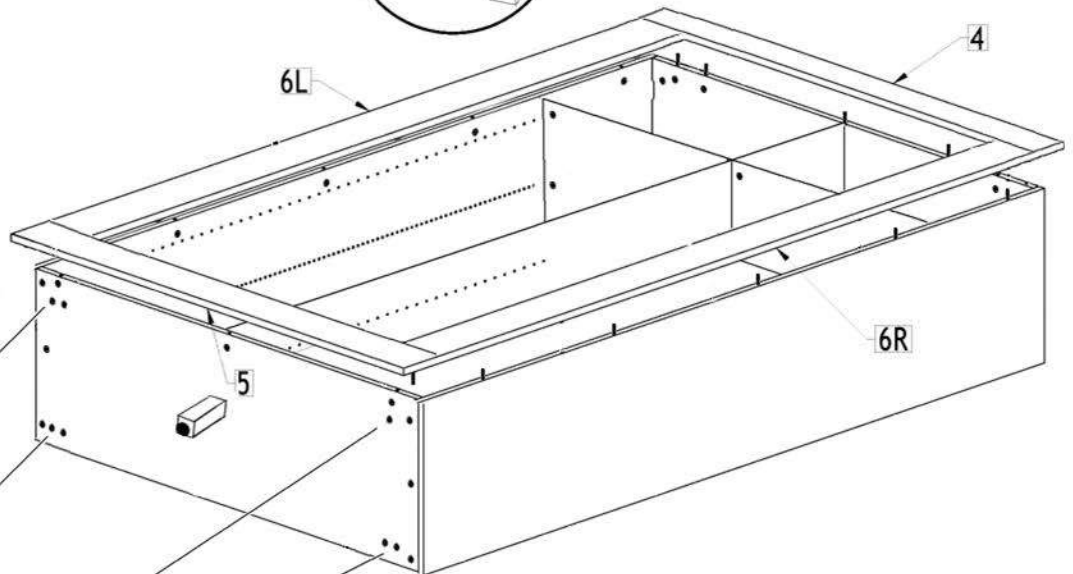
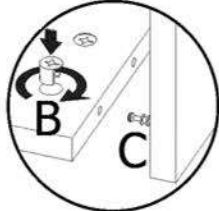
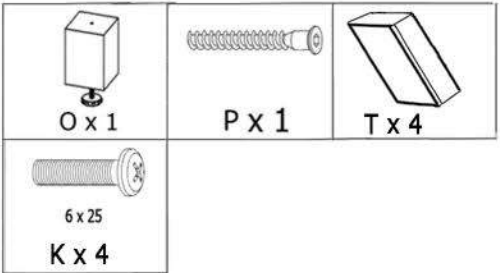

6

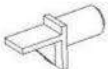

7





 H x 2	 I x 16	 3,5 x 13 E x 8
 J x 2	 4 x 45 K x 4	
 M x 4	 N x 6	

